

Estufas

Petit.....	3
Master.....	5
Heavy Duty	7

Freidoras

Petit.....	9
Master.....	10
Heavy Duty	10

Planchas

Petit.....	12
Master.....	13

Parrillas

Petit.....	15
Master	15
Heavy Duty	16

Asadores

Petit.....	19
Master	20

Salamandras

Petit.....	22
Master	22

Hornos

Petit.....	24
Master	25

Estufones

Master	27
--------------	----

Interceptores

Master	29
--------------	----

Accesorios

Bases Petit	31
Bases Master	32
Bases Heavy Duty	33
Ménsulas Petit	34
Ménsulas Master	34

Políticas de precios

.....	35
-------	----

Estufas









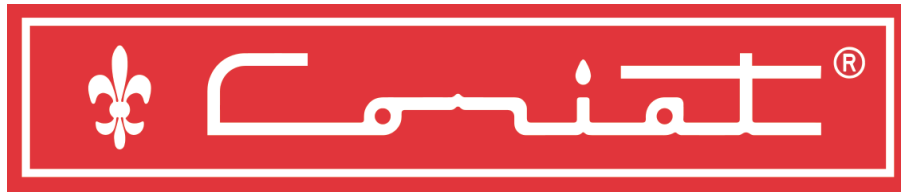

IMAGEN	CÓDIGO	MODELO	DESCRIPCIÓN
	17010511	EC-2-HM DE PISO PETIT	Estufa a gas, con 2 quemadores y 1 horno.
	16010511	EC-3-HG DE PISO PETIT	Estufa a gas, con 3 quemadores y 1 horno.
	16010611	EC-3-H-GRILL DE PISO PETIT	Estufa a gas, con 3 quemadores, 1 plancha, 1 gratinador y 1 horno.
	17010611	MINICHEF DE PISO PETIT	Estufa a gas, con 2 quemadores, 1 plancha y 1 gratinador y 1 horno.
	18010611	MINICHEF DE MESA PETIT	Estufa a gas, con 2 quemadores, 1 plancha y 1 gratinador.
	18010511	EC-3-GRILL DE MESA PETIT	Estufa a gas, con 3 quemadores, 1 plancha y 1 gratinador.
	17010711	MULTICHEF DE PISO PETIT	Estufa a gas, con 2 quemadores, 1 plancha, 1 gratinador, 1 freidora 3 lt y 1 horno.

IMAGEN	CÓDIGO	MODELO	DESCRIPCIÓN
	17010811	MULTICHEF TURBO DE PISO PETIT	Estufa a gas, con 2 quemadores, 1 plancha, 1 gratinador, 1 freidora 6.5 lt y 1 horno.
	18010711	MULTICHEF DE MESA PETIT	Estufa a gas, con 2 quemadores, 1 plancha, 1 gratinador y 1 freidora 3 lt.
	16010711	MULTIPLE DE PISO PETIT	Estufa a gas, con 2 quemadores, 1 asador, 1 plancha, 1 gratinador y 1 freidora 3 lt.
	16010811	MULTIPLE TURBO DE PISO PETIT	Estufa a gas, con 2 quemadores, 1 plancha, 1 asador, 1 gratinador, 1 freidora de 6.5 lt y 1 horno.
	18010811	MULTIPLE DE MESA PETIT	Estufa a gas, con 2 quemadores, 1 asador, 1 plancha, 1 gratinador y 1 freidora de 3 lt.







IMAGEN	CÓDIGO	MODELO	DESCRIPCIÓN
	17010111	EC-4-HM DE PISO MASTER	Estufa a gas, con 4 quemadores y 1 horno.
	16010111	EC-6-HG DE PISO MASTER	Estufa a gas, con 6 quemadores y 1 horno.
	17010211	MINICHEF DE PISO MASTER	Estufa a gas, con 4 quemadores, 1 plancha, 1 gratinador y 1 horno.
	16010211	EC-6-H-GRILL DE PISO MASTER	Estufa a gas, con 6 quemadores, 1 plancha, 1 gratinador y 1 horno.
	18010211	MINICHEF DE MESA MASTER	Estufa a gas, con 4 quemadores, 1 plancha y 1 gratinador.
	18010111	EC-6-GRILL DE MESA MASTER	Estufa a gas, con 6 quemadores, 1 plancha y 1 gratinador.
	17010311	MULTICHEF DE PISO MASTER	Estufa a gas, con 4 quemadores, 1 plancha, 1 gratinador, 1 freidora 3 lt y 1 horno.









IMAGEN	CÓDIGO	MODELO	DESCRIPCIÓN
	17010411	MULTICHEF TURBO DE PISO MASTER	Estufa a gas, con 4 quemadores, 1 plancha, 1 gratinador, 1 freidora 8 lt y 1 horno.
	18010311	MULTICHEF DE MESA MASTER	Estufa a gas, con 4 quemadores, 1 plancha, 1 gratinador y 1 freidora 3 lt.
	16010311	MULTIPLE DE PISO MASTER	Estufa a gas, con 4 quemadores, 1 asador, 1 plancha, 1 gratinador, 1 freidora de 3 lt y 1 horno.
	16010411	MULTIPLE TURBO DE PISO MASTER	Estufa a gas, con 4 quemadores, 1 asador, 1 plancha, 1 gratinador, 1 freidora 8 lt y 1 horno.
	18010411	MULTIPLE DE MESA MASTER	Estufa a gas, con 4 quemadores, 1 asador, 1 plancha, 1 gratinador y 1 freidora 3 lt.

IMAGEN	CÓDIGO	MODELO	DESCRIPCIÓN
	16010911	EC-4-HG DE PISO HD	Estufa a gas, con 4 quemadores extra grandes y 1 horno.
	16011011	EC-4-GA DE PISO HD	Estufa a gas, con 4 quemadores extra grandes, monta sobre gabinete abierto.
	16011311	EC-HG-GRILL DE PISO HD	Plancha 3/4" de espesor, 3 quemadores en "U", horno incluido. Máxima productividad.
	16011211	EC-GA-GRILL DE PISO HD	Plancha 3/4" de espesor, 3 quemadores en "U" y compartimiento abierto bajo plancha.

Freidoras





Freidoras PETIT

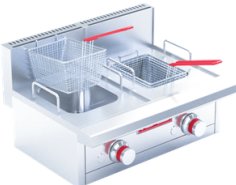



IMAGEN	CÓDIGO	MODELO	DESCRIPCIÓN
	20010211	FC-10 MESA PETIT	Freidora de mesa, a gas, una canastilla, con capacidad de 3 litros de aceite.
	20010311	FC-10-D MESA PETIT	Freidora de mesa, a gas, doble tina con capacidad de 3 litros de aceite cada una y 2 canastillas.

Freidoras Turbo PETIT

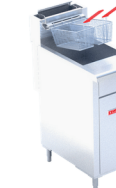
	20010411	TURBO-6.5-1Q DE PISO PETIT	Freidora de piso, a gas, 2 canastillas, 6.5 litros, 1 potente quemador y zona fría al fondo.
	20010511	TURBO-10-2Q DE PISO PETIT	Freidora de piso, a gas, 2 canastillas, 10 litros, 2 quemadores y zona fría al fondo.
	20010611	TURBO-12.5-3Q DE PISO PETIT	Freidora de piso, a gas, 2 canastillas, 12.5 litros, 3 quemadores y zona fría al fondo.
	20010711	TURBO-17-4Q DE PISO PETIT	Freidora de piso, a gas, 2 canastillas, 17 litros, 4 quemadores y zona fría al fondo.
	20010811	TURBO-19-5Q DE PISO PETIT	Freidora de piso, a gas, 2 canastillas, 19 litros, 5 quemadores y zona fría al fondo.

IMAGEN	CÓDIGO	MODELO	DESCRIPCIÓN
	20010911	TURBO-8-1Q DE PISO MASTER	Freidora de piso, a gas, 2 canastillas, 8 litros, 1 potente quemador y zona fría al fondo.
	20011011	TURBO-16-2Q DE PISO MASTER	Freidora de piso, a gas, 2 canastillas, 16 litros, 2 quemadores y zona fría al fondo.
	20011111	TURBO-20-3Q DE PISO MASTER	Freidora de piso, a gas, 2 canastillas, 20 litros, 3 quemadores y zona fría al fondo.

Freidoras HEAVY DUTY

	20011211	TURBO-25.5-4Q DE PISO HD	Freidora de piso, a gas, 2 canastillas, 25.5 litros, 3 quemadores y zona fría al fondo.
	20011311	TURBO-30-5Q DE PISO HD	Freidora de piso, a gas, 2 canastillas, 30 litros, 5 quemadores y zona fría al fondo.

Planchas















IMAGEN	CÓDIGO	MODELO	DESCRIPCIÓN
	26010511	CH-1 DE MESA PETIT	Plancha a gas, con 1 quemador tubular, placa de 3/4" de espesor.
	26010611	CH-2 DE MESA PETIT	Plancha a gas, con 2 quemadores tubulares, placa de 3/4" de espesor.
	26010711	CH-3 DE MESA PETIT	Plancha a gas, con 3 quemadores tubulares, placa de 3/4" de espesor.
	26010811	CH-4 DE MESA PETIT	Plancha a gas, con 4 quemadores tubulares, placa de 3/4" de espesor.

IMAGEN	CÓDIGO	MODELO	DESCRIPCIÓN
	26010111	CV-1 MASTER	Plancha a gas, con 1 quemador tipo "U", placa de 3/4" de espesor.
	26010211	CV-2 MASTER	Plancha a gas, con 2 quemadores tipo "U", placa de 3/4" de espesor.
	26010311	CV-3 MASTER	Plancha a gas, con 3 quemadores tipo "U", placa 3/4" de espesor.
	26010411	CV-4 MASTER	Plancha a gas, con 4 quemadores tipo "U", placa de 3/4" de espesor.

Parrillas



IMAGEN	CÓDIGO	MODELO	DESCRIPCIÓN
	25010511	PCH-1 DE MESA PETIT	Parrilla a gas, con 1 quemador solido, 1 parrilla en hierro gris y 1 cubierta semi-sellada.
	25010611	PCH-2 DE MESA PETIT	Parrilla a gas, con 2 quemadores, 2 parrillas en hierro gris y 2 cubiertas semi-selladas.
	25010711	PCH-3 DE MESA PETIT	Parrilla a gas, con 3 quemadores, 3 parrillas en hierro gris y 3 cubiertas semi-selladas.
	25010811	PCH-4 DE MESA PETIT	Parrilla a gas, con 4 quemadores, 4 parrillas en hierro gris y 4 cubiertas semi-selladas.

Parrillas horizontales MASTER











IMAGEN	CÓDIGO	MODELO	DESCRIPCIÓN
	25010111	PCV-2 DE MESA MASTER	Parrilla a gas, con 2 quemadores, 1 parrilla en hierro fundido montada sobre cubierta semi-sellada.
	25010211	PCV-4 DE MESA MASTER	Parrilla a gas, con 4 quemadores, 2 parrillas en hierro fundido y 2 cubiertas semi-selladas.

IMAGEN	CÓDIGO	MODELO	DESCRIPCIÓN
	25010311	PCV-6 DE MESA MASTER	Parrilla a gas, con 6 quemadores, 3 parrillas en hierro fundido montadas sobre cubierta semi-sellada.
	25010411	PCV-8 DE MESA MASTER	Parrilla a gas, con 8 quemadores, 4 parrillas en hierro fundido montadas sobre cubierta semi-sellada.

Parrillas horizontales HEAVY DUTY

IMAGEN	CÓDIGO	MODELO	DESCRIPCIÓN
	25011311	PCH-1 DE MESA HD	Parrilla a gas, con 1 quemador, 1 parrillas en hierro fundido y 1 cubierta semi-sellada.
	25011411	PCH-2 DE MESA HD	Parrilla a gas, con 2 quemadores, 2 parrillas en hierro fundido y 2 cubiertas semi-selladas.
	25011511	PCH-3 DE MESA HD	Parrilla a gas, con 3 quemadores, 3 parrillas en hierro fundido y 3 cubiertas semi-selladas.
	25011611	PCH-4 DE MESA HD	Parrilla a gas, con 4 quemadores, 4 parrillas en hierro fundido y 4 cubiertas semi-selladas.

Parrillas verticales HEAVY DUTY

IMAGEN	CÓDIGO	MODELO	DESCRIPCIÓN
	25010911	PCV-2 DE MESA HD	Parrilla a gas, con 2 quemadores, 1 parrilla en hierro fundido y 1 cubierta semi-sellada.
	25011011	PCV-4 DE MESA HD	Parrilla a gas, con 4 quemadores, 2 parrillas en hierro fundido y 2 cubiertas semi-selladas.
	25011111	PCV-6 DE MESA HD	Parrilla a gas, con 4 quemadores, 2 parrillas en hierro fundido y 2 cubiertas semi-selladas.

Parrillas horizontales HEAVY DUTY

IMAGEN	CÓDIGO	MODELO	DESCRIPCIÓN
	25011211	PCV-8 DE MESA HD	Parrilla a gas, con 8 quemadores, 4 parrillas en hierro fundido y 4 cubiertas semi-selladas.

Asadores







IMAGEN	CÓDIGO	MODELO	DESCRIPCIÓN
	10010511	ACH-1 DE MESA PETIT	Asador a gas, con 1 parrilla reversible.
	10010611	ACH-2 DE MESA PETIT	Asador a gas, con 2 parrillas reversibles.
	10010711	ACH-3 DE MESA PETIT	Asador a gas, con 3 parrillas reversibles.
	10010811	ACH-4 DE MESA PETIT	Asador a gas, con 4 parrillas reversibles.

IMAGEN	CÓDIGO	MODELO	DESCRIPCIÓN
	10010111	ACV-1 DE MESA MASTER	Asador a gas, con 1 parrilla reversible.
	10010211	ACV-2 DE MESA MASTER	Asador a gas, con 2 parrillas reversibles.
	10010311	ACV-3 DE MESA MASTER	Asador a gas, con 3 parrillas reversibles.
	10010411	ACV-4 DE MESA MASTER	Asador a gas, con 4 parrillas reversibles.

Salamandras





IMAGEN	CÓDIGO	MODELO	DESCRIPCIÓN
	28010111	SC-16.5-G PETIT	Salamandra a gas, para 1 platillo de 0.25 m de Ø, con 1 quemador "infra-rojo", palanca de 5 posiciones.

Salamandra MASTER

IMAGEN	CÓDIGO	MODELO	DESCRIPCIÓN
	28010211	SC-31.5-G MASTER	Salamandra a gas, para 2 platillos de 0.250 m de Ø, con 2 quemadores "infra-rojos", palanca de 5 posiciones.



Hornos



IMAGEN	CÓDIGO	MODELO	DESCRIPCIÓN
	21010511	PIZZINO-1 PETIT	Horno a gas, con capacidad para 1 pizza de 40 cm de Ø, piso refractario, controlado por 1 termostato digital.
	21010611	PIZZINO-2 PETIT	Horno a gas, con capacidad para 2 pizzas de 40 cm de Ø, piso refractario, controlado por 1 termostato digital.
	21010711	PIZZINO-3 PETIT	Horno a gas, con capacidad para 3 pizzas de 40 cm de Ø, piso refractario, controlado por 1 termostato digital.

Hornos de Usos Múltiples MASTER

	21010111	HC-35 MASTER	Horno a gas, una gaveta, capacidad de 5 charolas de 65x45 cm. Termostato con válvula de seguridad integrada. Rango de temperatura de 100 a 300°C. Certificado CSA uso comercial.
	21010211	HC-35-D MASTER	Horno a gas, dos gavetas, capacidad total de 10 charolas de 65x45 cm. 2 Termostatos con válvula de seguridad integrada, rango de temperatura de 100° a 300°C, certificados CSA uso comercial.

IMAGEN	CÓDIGO	MODELO	DESCRIPCIÓN
	21010311	HC-35-C MASTER	Horno de convección a gas, con capacidad de 5 charolas de 53x32.5 cm, controlado por 1 termostato digital.
	21010411	HC-35-C-XL MASTER	Horno de convección a gas, con capacidad de 5 charolas de 65.5x51.6 cm, controlado por 1 termostato digital.

Hornos Pizza MASTER

	21010811	PIZZA-4 MASTER	Horno a gas, con capacidad para 4 pizzas de 40 cm de Ø, piso refractario, controlado por 1 termostato digital.
	21010911	PIZZA-6 MASTER	Horno a gas, con capacidad para 6 pizzas de 40 cm de Ø, piso refractario, controlado por 1 termostato digital.

Estufones











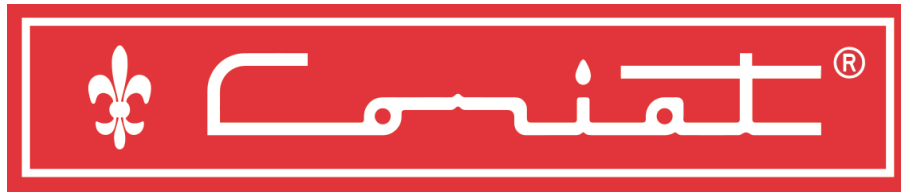

IMAGEN	CÓDIGO	MODELO	DESCRIPCIÓN
	19010111	EC-1T MASTER	Estufon a gas, 1 sección con 1 potente quemador concéntrico en hierro fundido de de 70000 BTU/hr. Perfecto para cocinar con 1 olla grande.
	19010211	EC-2T MASTER	Estufon a gas, 2 secciones con 2 potentes quemadores concéntricos n hierro fundido de 70000 BTU/hr.
	19010311	EC-3T MASTER	Estufon a gas, 3 secciones con 3 potentes quemadores concéntricos en hierro fundido de 70000 BTU/hr.
	19011411	SP-1T	Estufon a gas, 1 sección con 1 potente quemador concéntrico en hierro fundido de de 70000 BTU/hr. Perfecto para cocinar con 1 olla grande.
	19011511	SP-2T	Estufon a gas, 2 secciones con 2 potentes quemadores concéntricos n hierro fundido de 70000 BTU/hr.
	19011611	SP-3T	Estufon a gas, 3 secciones con 3 potentes quemadores concéntricos en hierro fundido de 70000 BTU/hr.

Interceptores



IMAGEN	CÓDIGO	MODELO	DESCRIPCIÓN
	31010107	IC-38	Interceptor de grasa con capacidad de almacenaje de 9 kg de grasa y capacidad de flujo de 38 lt por minuto.
	31010207	IC-75	Interceptor de grasa con capacidad de almacenaje de 18 kg de grasa y capacidad de flujo de 75 lt por minuto.
	31010307	IC-132	Interceptor de grasa con capacidad de almacenaje de 32 kg de grasa y capacidad de flujo de 132 lt por minuto.
	31010407	IC-187	Interceptor de grasa con capacidad de almacenaje de 45 kg de grasa y capacidad de flujo de 187 lt por minuto.

Accesorios









IMAGEN	CÓDIGO	MODELO
	30010617	BASE 29 CM PETIT (CH-1 DE MESA PETIT, PCH-1 DE MESA PETIT, ACH-1 DE MESA PETIT)
	30010817	BASE 59 CM PETIT (CH-2 DE MESA PETIT, PCH-2 DE MESA PETIT)
	30011017	BASE 88 CM PETIT (CH-3 DE MESA PETIT, PCH-3 DE MESA PETIT, ACH-3 DE MESA PETIT, PCH-2 DE MESA PETIT)
	30011217	BASE 118 CM PETIT (CH-4 DE MESA PETIT, PCH-4 DE MESA PETIT, ACH-4 DE MESA PETIT)
	30010317	BASE FC-10 PETIT (FC-10 PETIT)
	30010417	BASE FC-10-D PETIT (FC-10-D PETIT)















IMAGEN	CÓDIGO	MODELO
	30010517	BASE 29 CM MASTER (CV-1 DE MESA MASTER, PCV-2 DE MESA MASTER, ACV-1 DE MESA MASTER)
	30010717	BASE 59 CM MASTER (CV-2 DE MESA MASTER, PCV-4 DE MESA MASTER, ACV-2 DE MESA MASTER)
	30010917	BASE 88 CM MASTER (CV-3 DE MESA MASTER, PCV-6 DE MESA MASTER, ACV-3 DE MESA MASTER, PCV-4 DE MESA HD)
	30011117	BASE 118 CM MASTER (CV-4 DE MESA MASTER, PCV-8 DE MESA MASTER, ACV-4 DE MESA MASTER)
	30012017	BASE EC-6-GRILL MESA MASTER (EC-6-GRILL DE MESA MASTER)
	30012117	BASE MINICHEF MESA MASTER (MINICHEF DE MESA MASTER)
	30012317	BASE MULTICHEF MESA MASTER (MULTICHEF DE MESA MASTER)
	30012517	BASE MULTIPLE MESA MASTER (MULTIPLE DE MESA MASTER)

IMAGEN	CÓDIGO	MODELO
	30011617	BASE 44 CM V-HD (PCV-2 DE MESA HD)
	30011317	BASE 44 CM H-HD (PCH-1 DE MESA HD)
	30011717	BASE 132 CM V-HD (PCV-6 DE MESA HD)
	30011417	BASE 132 CM H-HD (PCH-3 DE MESA HD)
	30011817	BASE 176 CM V-HD (PCV-8 DE MESA HD)
	30011517	BASE 176 CM H-HD (PCH-4 DE MESA HD)

Ménsulas PETIT



IMAGEN	CÓDIGO	MODELO
	30012717	MENSULA SC-16.5-G PETIT (SC-16.5-G PETIT)

Ménsulas MASTER

	30012817	MENSULA SC-31.5-G MASTER (SC-31.5-G MASTER)
---	----------	--